

Smart Security anti-theft Helmet Lock for Bicycle/Scooter/Moped/Motorcycle Unlocking Via Mobile APP or Serial Port One-stop Easy Manage

Omni Smart Security anti-theft helmet Lock, which is sense of IoT technology, with super smart features, it is sure to meet the need of urban mobility solutions.

Omni is a smart helmet lock manufacturer of bicycles, scooters, electric bikes and others. It is for the best IoT solutions for mobility and fleet manufacturers.

Advantage of functions :

- 1, Convenient operation
- 2, Widely used
- 3, Security and anti-theft
- 4, Long battery life
- 5, Easy to borrow and return
- 6, Two type installations

Helmet lock

SECURITY ANTI-THEFT HELMET LOCK

With Superior quality Helmet Locks, Greatly to
reduce Helmets damage and missing





APPLICATION
BACKGROUND



APPLICATION BACKGROUND

Based on safety system,aim at safe riding and to effective manage of scooters,E-bicycles,Motorcycles,Bicycles,etc.



2 OPTIONS FOR SWITCH



Bluetooth Unlock
by Mobile APP



IOT Switch Lock
with Serial port

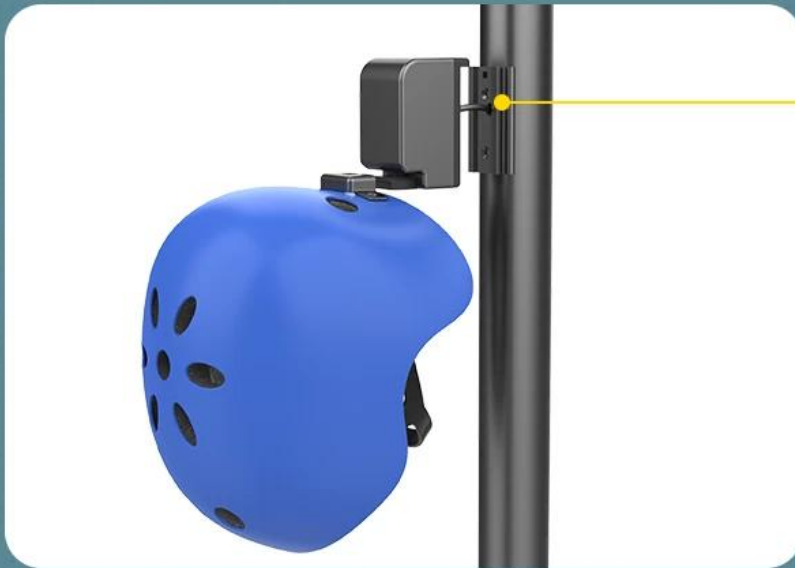

IOT version: Use UART communication wire connect with IOT, IOT can control lock status.

Bluetooth version: Add suitable bracket, connect with phone app via BLE, App remote control lock status.

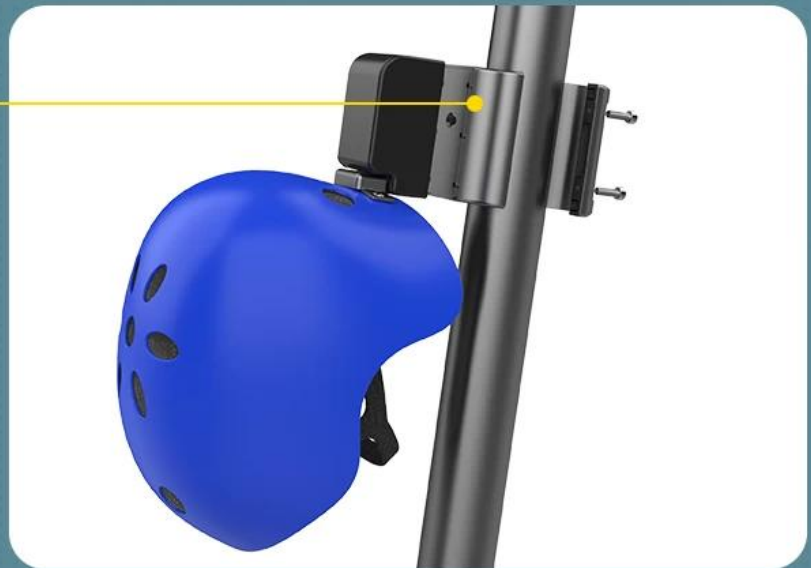

COMPARISON



Other Products in market



Helmets are locked by rope,
Very easy to Knotting,
damaged and missing



Helmets placed in a fixed
station, disconnected with
riding tools, Consume a lot of
time to find station



Helmets hang with rope
disorderly, easy to drop
and crash



Helmets with mechanical
locks, poor efficiency with
manually unlock

VS



Omni's helmet

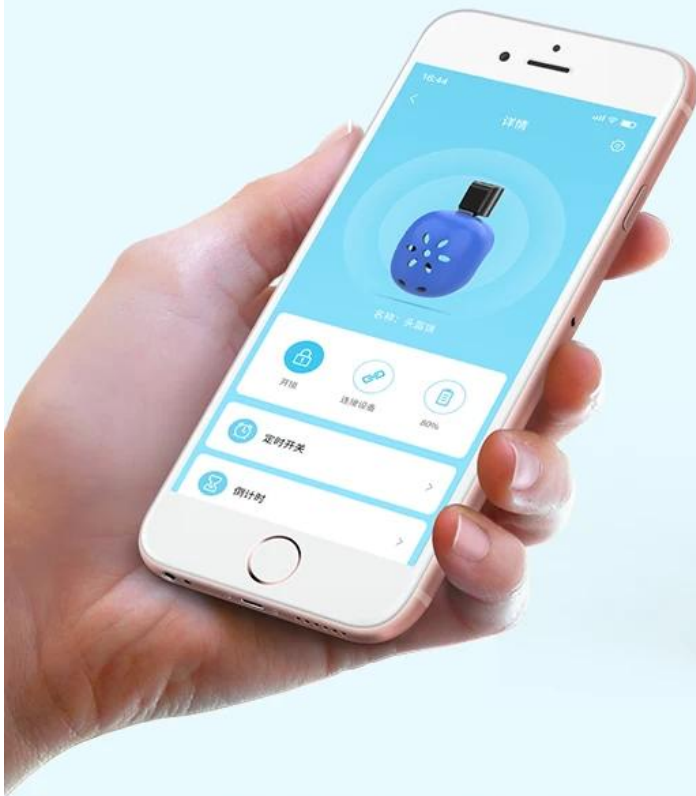

Helmet fixed on tub, Wiring hidden, Aesthetic and minimalist design, Bluetooth wireless connection, APP switch lock/unlock, one-stop easily to manage

PATENTED SECURITY IDENTIFICATION AND ANTI-THEFT TECHNOLOGY



Patented electromagnetic induction
technology Identified Helmets Unlock/Lock for
borrowing and returning



WATERPROOF AND DUSTPROOF



IP67 Degree ,well sealed,easy to
cope with severe weather



WIDE VOLTAGE LITHIUM BATTERY



Use 12-48V wide voltage,
3.6V/3600mAh lithium battery

Multi-voltage
input

Fast
charging

Stable
performance



WIDE RANGE OF APPLICATION SCENARIOS



Mostly used in riding tools such as shared bicycles, electric mopeds, scooters, electric vehicles, motorcycles, etc.



REAL VIEW

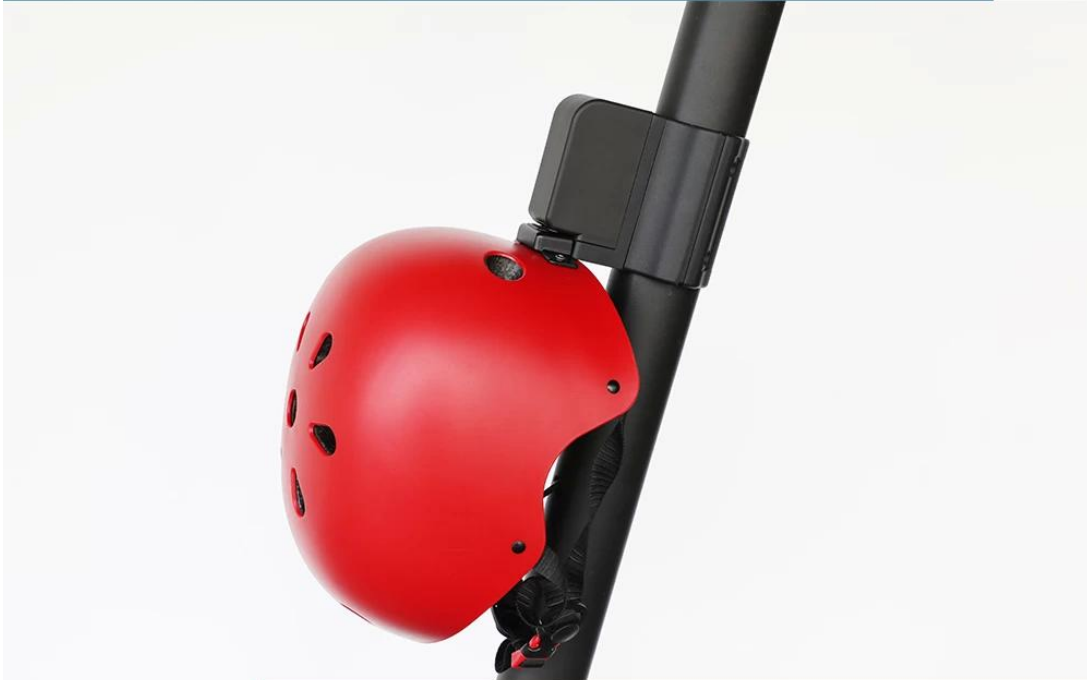
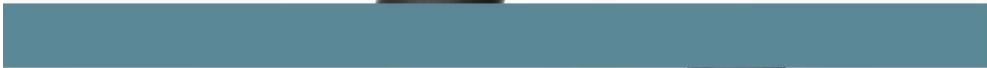



PHYSICAL DIMENSION

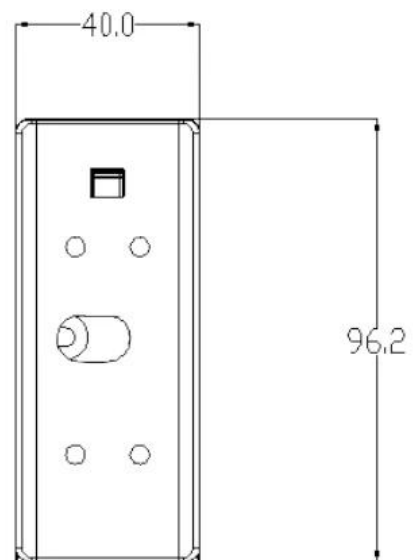
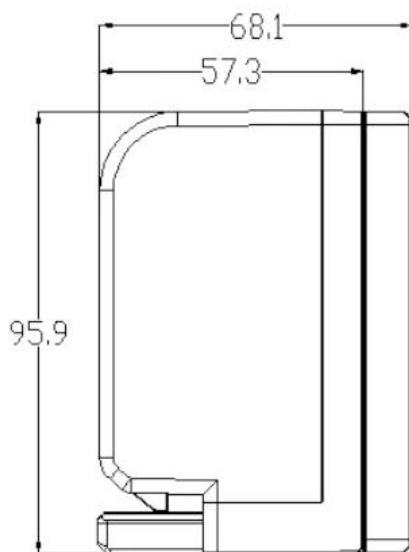

About Omni

Shenzhen Omni Intelligent Technology Co., Ltd specializes in the products of wireless communication,artificial intelligent,sensor technology,which is a national high-tech enterprise integrated the development of hardware,software and system solutions.Omni products has been popular more than 100 countries and districts and the product ranges are: [smart parking management](#),[smart sharing bicycle system](#),[sharing electric scooter system](#),smart home,[smart cycling](#),smart personal products and other artificial intelligent hardware and APP,server program, backstage management system.

Omni is dedicated in providing the optimal smart products,solutions and services for both domestic and global customers by adhering to the OMNI philosophy "Technology Innovation, Product Updation,Service Concentration".

The company cases

Intelligent riding system solution

Sharing bike

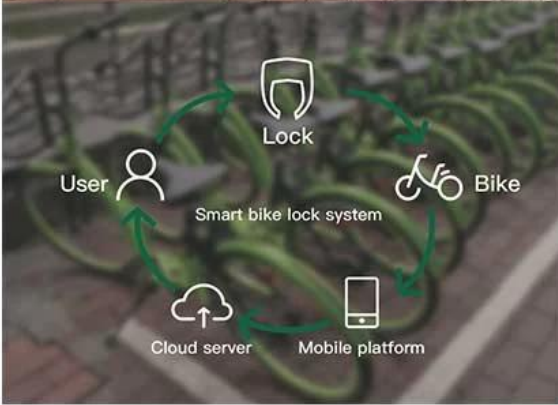

Sharing parking



Sharing scooter



The strength of company

Sales team



Engineering R&D

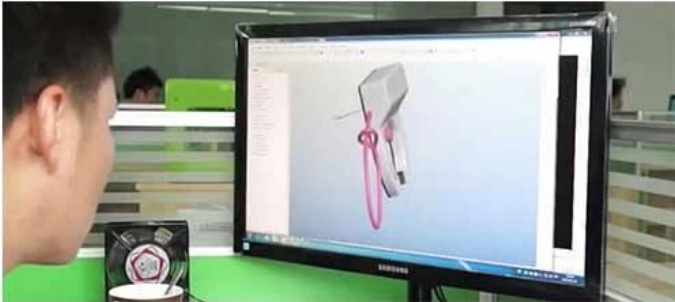

Production plant

