

## **Lucchetto antifurto per casco Smart Security per sblocco di biciclette/scooter/ciclomotori/moto tramite APP mobile o porta seriale One-stop Easy Manage**

Omni il lucchetto antifurto per casco Smart Security, che è il senso della tecnologia IoT, con funzionalità super intelligenti, soddisferà sicuramente le esigenze di soluzioni di mobilità urbana.

Omni è un produttore di lucchetti per casco intelligenti per biciclette, scooter, bici elettriche e altri. Offre le migliori soluzioni IoT per i produttori di mobilità e flotte.

### **Vantaggio delle funzioni :**

- 1, funzionamento conveniente
- 2, ampiamente utilizzato
- 3, Sicurezza e antifurto
- 4, batteria a lunga durata
- 5, Facile prendere in prestito e restituire
- 6, installazioni di tipo due

*Helmet lock*

# SECURITY ANTI-THEFT HELMET LOCK

With Superior quality Helmet Locks, Greatly to  
reduce Helmets damage and missing





APPLICATION  
BACKGROUND



# APPLICATION BACKGROUND

Based on safety system,aim at safe riding and to effective manage of scooters,E-bicycles,Motorcycles,Bicycles,etc.



# 2 OPTIONS FOR SWITCH



Bluetooth Unlock  
by Mobile APP



IOT Switch Lock  
with Serial port

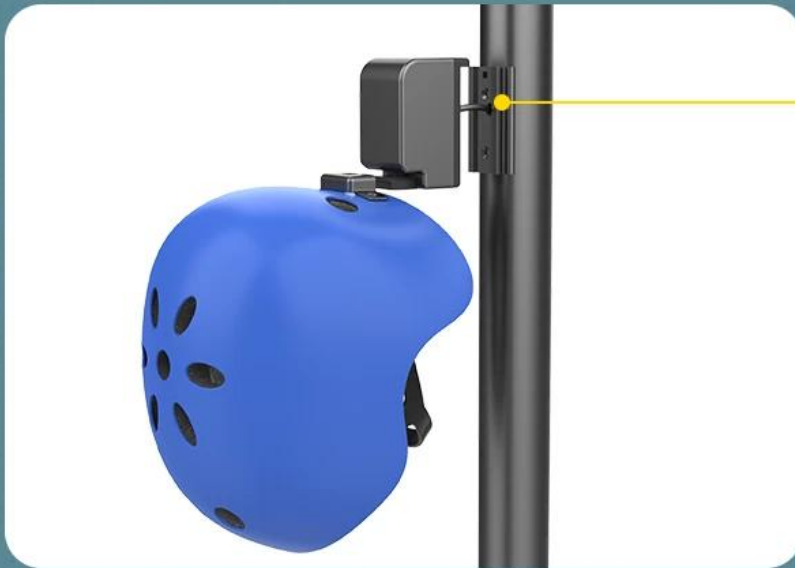

IOT version: Use UART communication wire connect with IOT, IOT can control lock status.

---

---

Bluetooth version: Add suitable bracket, connect with phone app via BLE, App remote control lock status.

---

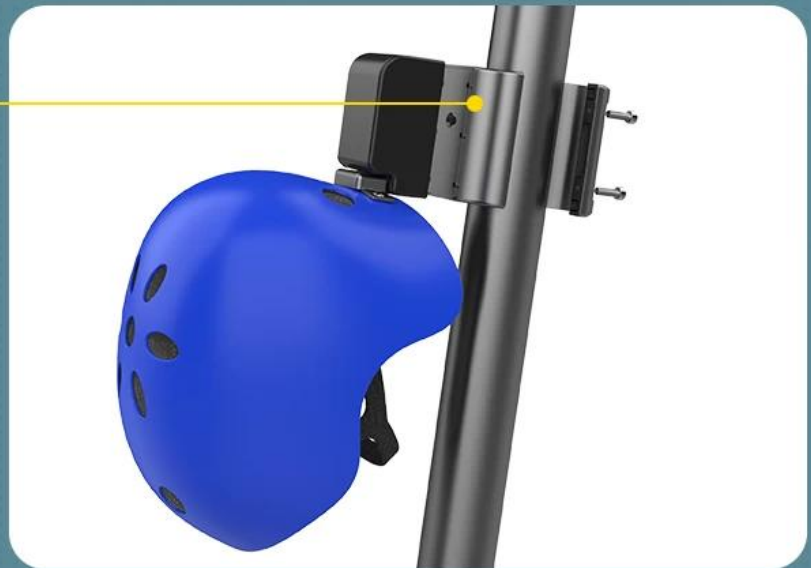



# COMPARISON



## Other Products in market



Helmets are locked by rope, Very easy to Knotting, damaged and missing



Helmets placed in a fixed station, disconnected with riding tools, Consume a lot of time to find station



Helmets hang with rope disorderly, easy to drop and crash



Helmets with mechanical locks, poor efficiency with manually unlock

# VS



## Omni's helmet

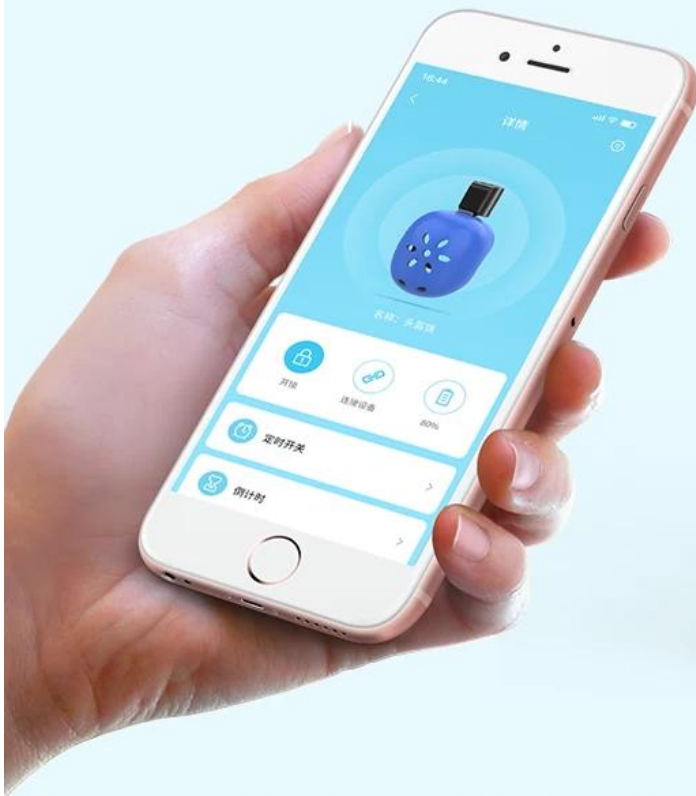

Helmet fixed on tub, Wiring hidden, Aesthetic and minimalist design, Bluetooth wireless connection, APP switch lock/unlock, one-stop easily to manage

# PATENTED SECURITY IDENTIFICATION AND ANTI-THEFT TECHNOLOGY



Patented electromagnetic induction  
technology Identified Helmets Unlock/Lock for  
borrowing and returning





# WATERPROOF AND DUSTPROOF



IP67 Degree ,well sealed,easy to  
cope with severe weather



# WIDE VOLTAGE LITHIUM BATTERY



Use 12-48V wide voltage,  
3.6V/3600mAh lithium battery

Multi-voltage  
input

Fast  
charging

Stable  
performance





# WIDE RANGE OF APPLICATION SCENARIOS



Mostly used in riding tools such as shared bicycles, electric mopeds, scooters, electric vehicles, motorcycles, etc.



# REAL VIEW

---

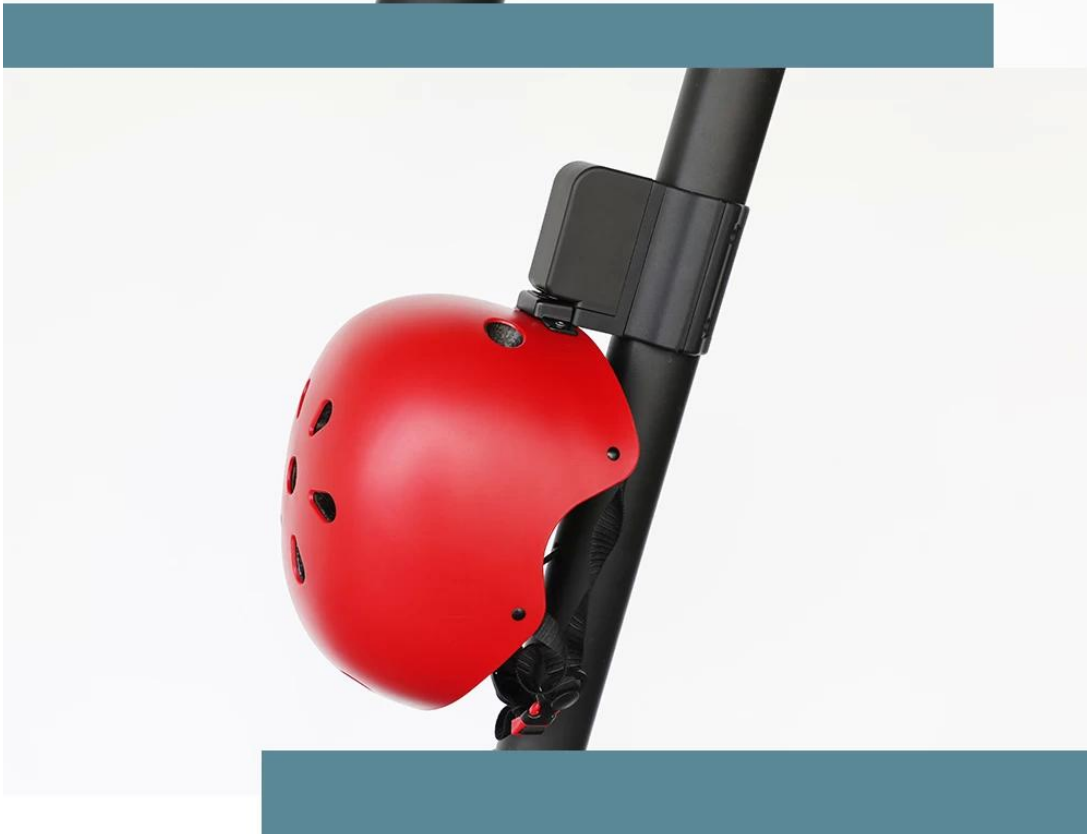





## PHYSICAL DIMENSION

---

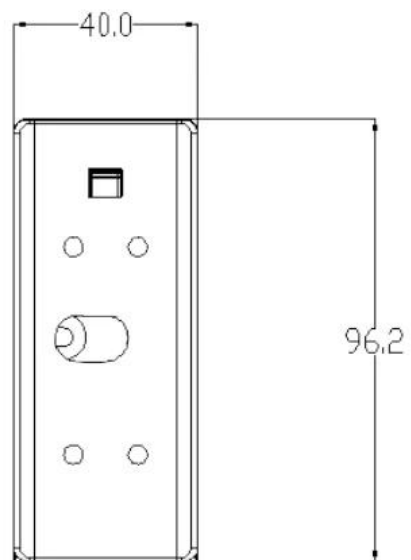
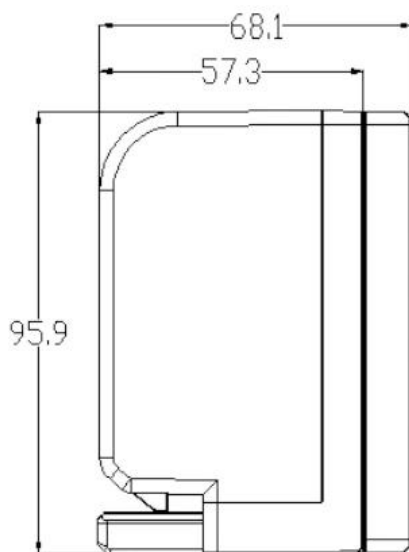

## **DiOmni**

Shenzen Omni Intelligent Technology Co., Ltd è specializzata in prodotti di comunicazione wireless, intelligenza artificiale e tecnologia dei sensori, che è un'impresa high-tech nazionale che integra lo sviluppo di soluzioni hardware, software e di sistema. Omni i prodotti sono apprezzati in più di 100 paesi e distretti e le gamme di prodotti sono: [gestione intelligente dei parcheggi](#), [sistema di condivisione intelligente delle biciclette](#), [condivisione del sistema di scooter elettrici](#), [casa intelligente](#), [ciclismo intelligente](#), prodotti personali intelligenti e altro hardware e APP di intelligenza artificiale, programma server, sistema di gestione del backstage.

Omni si dedica a fornire prodotti, soluzioni e servizi intelligenti ottimali sia per i clienti nazionali che globali aderendo al OMNI filosofia "Innovazione tecnologica, aggiornamento del prodotto, concentrazione del servizio".

# The company cases

Intelligent riding system solution

### Sharing bike

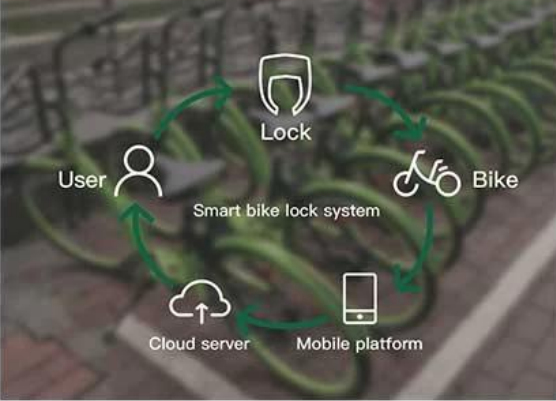

### Sharing parking



### Sharing scooter



# The strength of company

Sales team



Engineering R&D

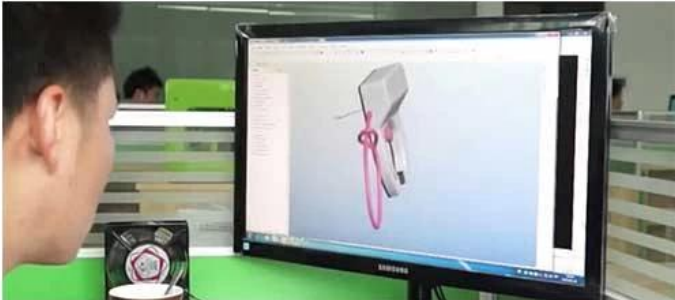

Production plant

