

Omni cabinet lock is the world's most advanced bluetooth smart lock. Smart lock attaches to any cabinet, closet, or drawer and installs in seconds - providing protection for a lifetime. No need for keys or latches to open, the Smart lock app is now your key, always on and always connected.

Omni cabinet lock is a bluetooth locking device and the first real solution when it comes to protecting what matters. Easily install the device to any cupboard, cabinet or drawer and sync with the Smart lock app to turn your phone into the key.



Bluetooth Cabinet Lock





App Unlock



Auto Lock



Remote Control

For House

Makes your family be more safer

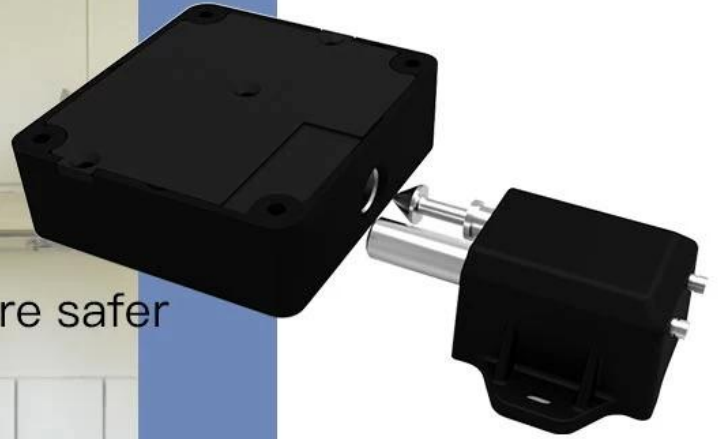



Never worry about the files lost

For Office





01



Keyless



One step to unlock



02

Invisible warded installation
Simple drop
Beautiful and safe



03

Low battery reminding because it wouldn't be opened without power.

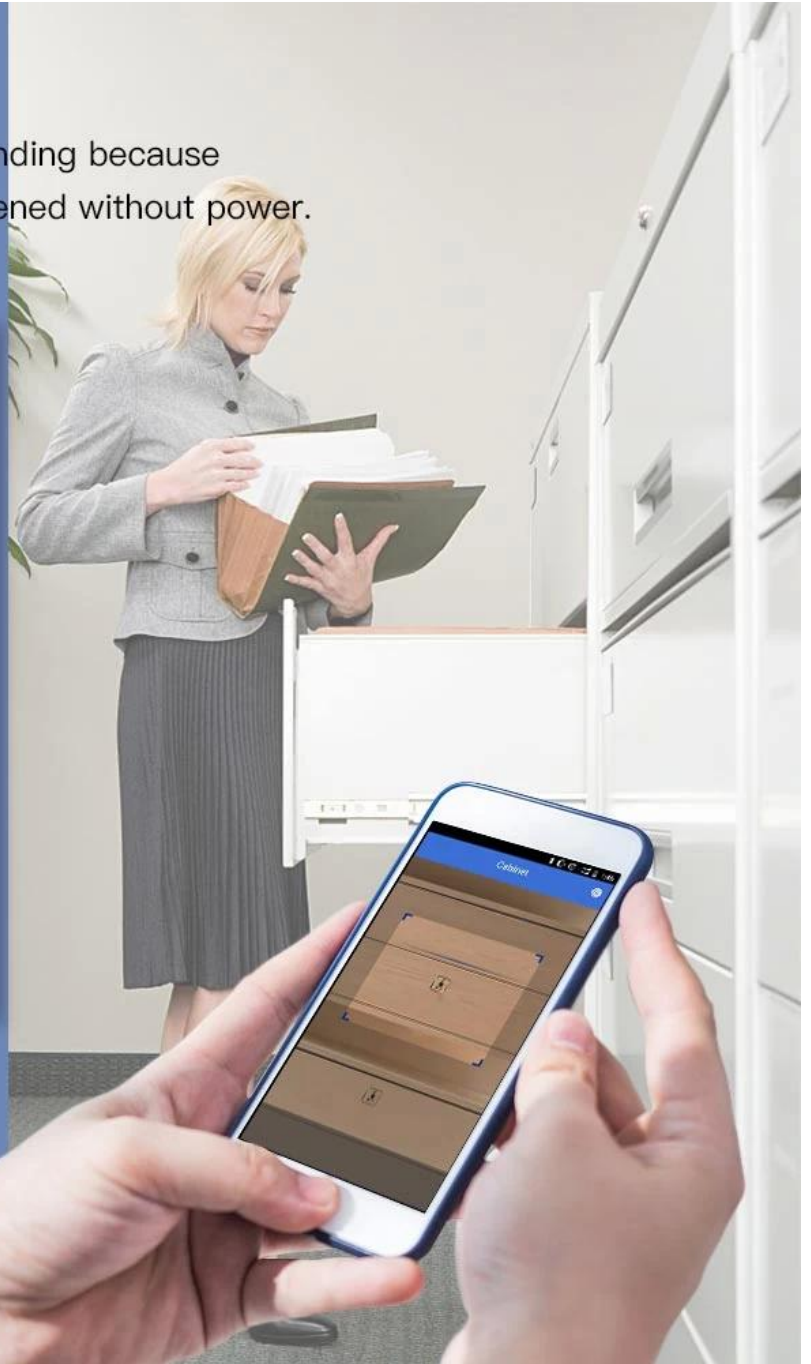
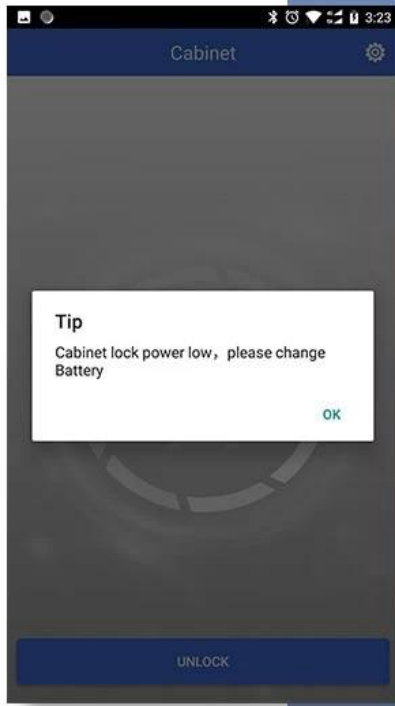

L O W P O W E R

C O N S U M P T I O N

THE PERFORMANCE
OF THE CONTROL

Low power design of the battery-powered measure-nodes is one of the key technologies of whether or not the system is feasible.

STABLE PERFORMANCE

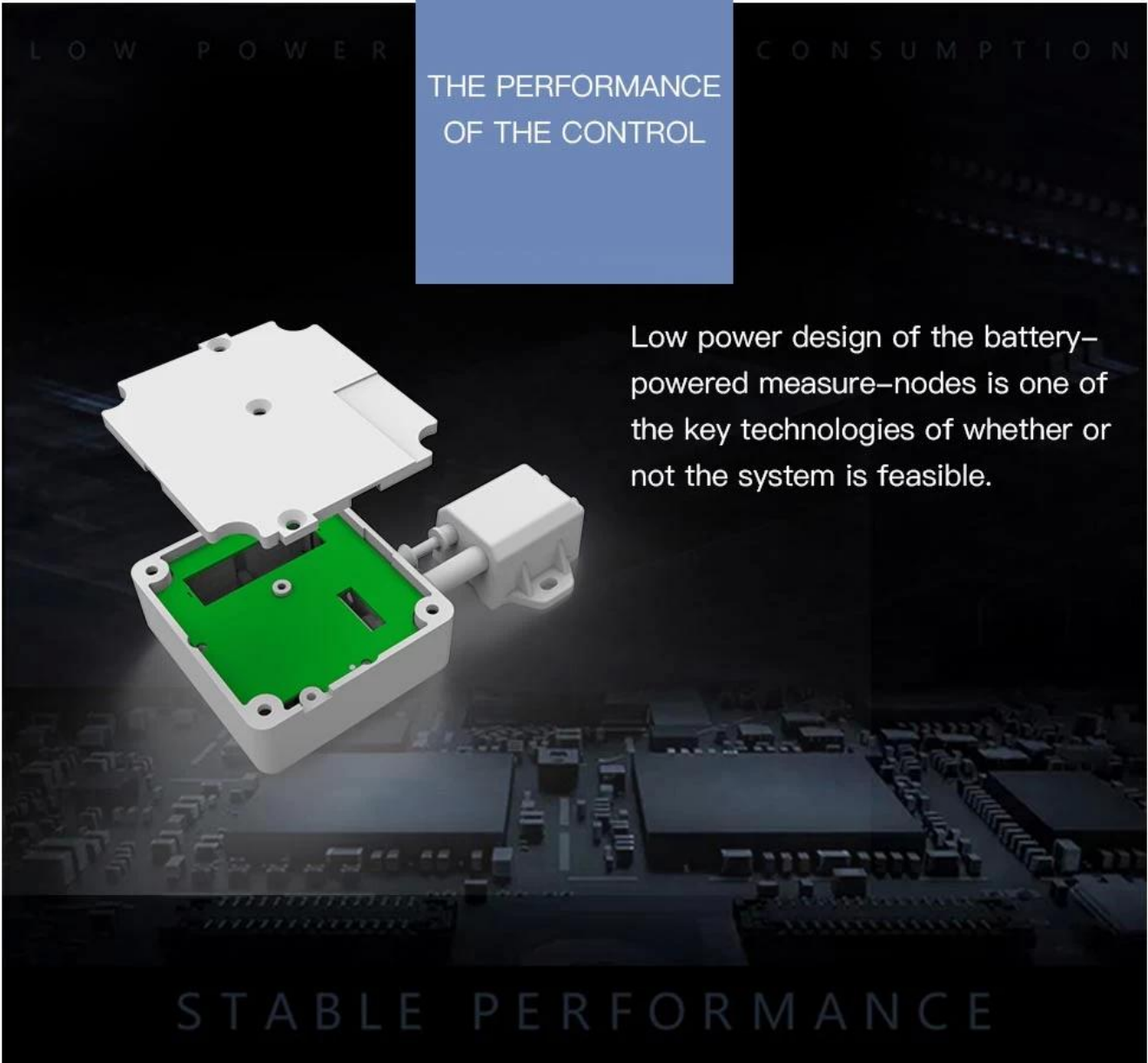

WORKING ANGLE

Choose an appropriate installation angle as the actual situation of your cabinet.

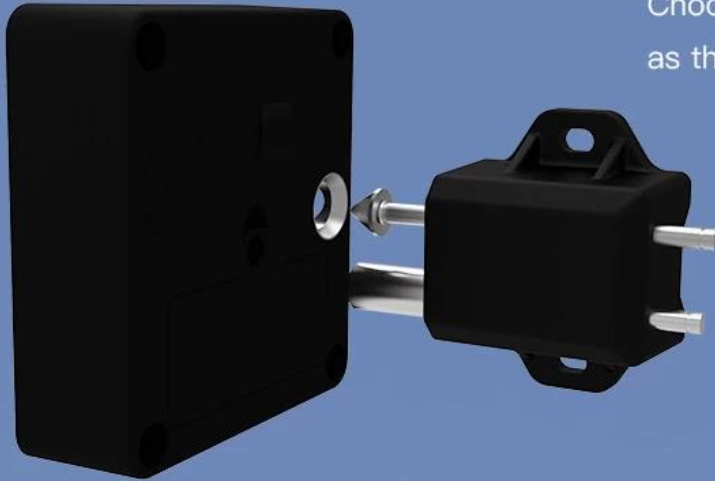

90° installation



180° installation

Installation

1 The lock will be activated by SONY or Panasonic battery CR123A, 3V,1400mAh. Also, make sure the electrode is correct. When the battery is installed, the lock beeps.

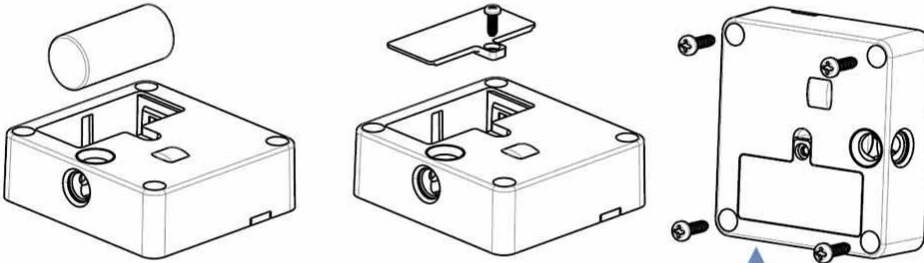

2 Before install, please test the master with lock and unlock function normally.

3 The lock can only be installed the materials like wood, plastic and non-magnetic materials that a maximum thickness of 25mm.

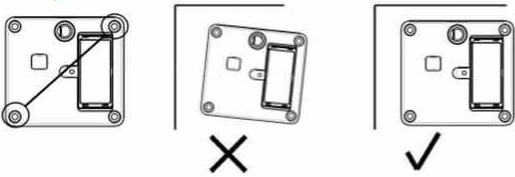

4 When you pulled up two pairs of screw, you need to check the position correct and must make the necessary adjustment before fixing up the screws.

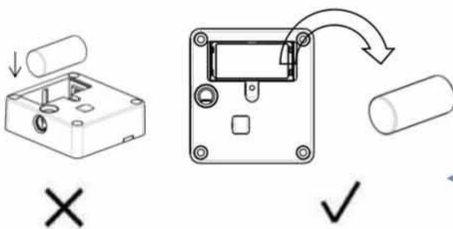
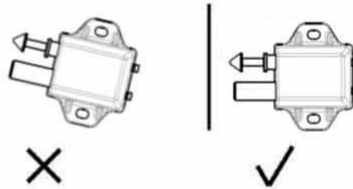

5 The operation during the process of storehouse and shipment.

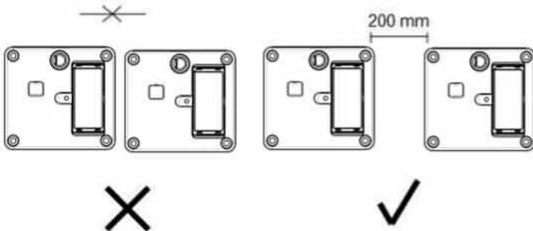

Technology specifications

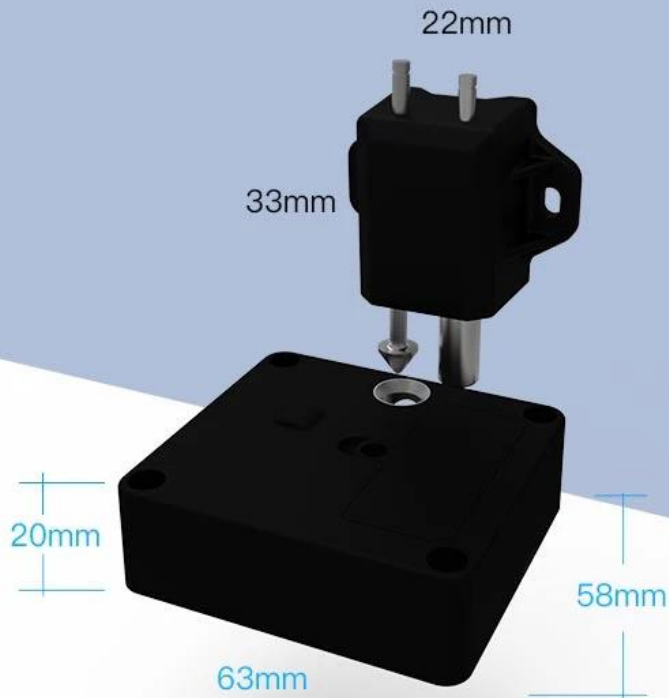

Size	63mmX58mmX20mm
Weight	55g (without battery)
Environment temperature	0° ~ +60° C
Humidity	20% ~ 75% relative humidity, no condensation
Battery	CR123A, 3V, Lithium battery
Battery lifespan	1 year or 1000 unlocking times
Bluetooth	Radio distance 10meters
Operation way APP	smart phone number registration account

● PRODUCT SPECIFICATIONS



Brand name	Omni
Name	Drawer Lock/Cabinet Lock/Electronic Sensor Lock
Material	ABS environmental protection material
Product characteristics	Waterproof / moisture / high temperature / anti-corrosion
Size	62 x 57 x 20mm
Weight (without battery)	52g
Number of users	up to 45 users
Open ways	App to open door
Product Lifetime	Open at least 100,000 times
Scope of application	drawers, wardrobe cabinets, etc. single open or double open doors

Q: How to become Omni's distributor?

A: Distributor shall have related resources of product,market,customer,and technical support engineer.A specific Annual Sales shall be negotiated and confirmed by signing agency agreement between both parties.

Q: OEM, ODM Service is available?

A: If MOQ=1KPCS,could offer customers ODM&OEM products,better support and service.

Q: How about lead-time for bulk quantity?

A: Usually it takes about 2 weeks.

Q: Compared with peer competitors,what is the advantage of Omni?

A: a. Focus on production.From product R&D,production to testing adopt high standards, strictly control the quality of products to ensure that they reach the top level.
b. New products available continuously, with strong R&D team of 40 engineers.
c. Mature experience & Strong ODM& OEM service.
d. Delivery on time, it is lower than 5% delay delivery in the past 10 years.
e. Good technical support,online & onsite technical support in time.

Q: What are solutions of Omni?

A: We provide solutions such as sharing bike lock system,sharing parking system,E-bike smart system.

Shenzhen Omni Intelligent Technology Co., Ltd. is located in Shenzhen Lianchuang Technical Zone,a national high-tech enterprise specializing in R&D,production and sales of intelligent transportation series and smart home products,integrating hardware and software development.Omni products has been popular in over 100 countries and regions around the world.

OMNI is dedicated in providing the optimal smart products,solutions and services for both domestic and global customers by adhering to the OMNI philosophy "Technology Innovation,Product Updation,Service Concentration".

Over 30 technology inventions and patents

Over 40 engineers and technicians in R & D Department

Over 200 employees in Omni Intelligent

Over 4000 □ office and production area



01. Focus on production, Having Strong strength

We specialize in producing smart electronic locks, sharing bike locks, sharing parking locks, anti-theft locks (glass door locks, electronic door locks, handle locks, luggage locks, cabinet door locks), patio door locks and other products. Omni is a national high-tech enterprise specializing in wireless communication, artificial intelligence, sensing technology, hardware and software development, and system development. Omni smart technology products sell well in more than 100 countries and regions around the world.



02. Advanced technology and stable production strength

From product R&D to technological innovation, from process manufacturing to quality testing, we insist on technological innovation to enhance brand competitiveness and provide consumers with high-quality experiences.

03. High quality service and excellent quality

Since its establishment, the company has been dedicated to providing customers with high quality products, reasonable prices, accurate delivery time, based on smart home, smart cycling, intelligent parking management industry, leading the industry's new trends..





TRANSACTION PROCESS



