

Intelligentes, diebstahlsicheres Helmschloss für Fahrräder/Roller/Mopeds/Motorräder. Entriegelung über mobile App oder serielle Schnittstelle - einfache Verwaltung aus einer Hand

OmniDas Diebstahlschutz-Helmschloss „Smart Security“ ist ein Sinnbild für IoT-Technologie und wird mit superintelligenten Funktionen den Anforderungen städtischer Mobilitätslösungen mit Sicherheit gerecht.

Omni ist ein Hersteller intelligenter Helmschlösser für Fahrräder, Motorroller, Elektrofahrräder und andere. Es steht für die besten IoT-Lösungen für Mobilitäts- und Flottenhersteller.

Vorteil der Funktionen :

- 1, bequeme Bedienung
- 2, weit verbreitet
- 3, Sicherheit und Anti-Diebstahl
- 4, lange Lebensdauer der Batterie
- 5, Einfach auszuleihen und zurückzugeben
- 6,Zwei Typ Installationen

Helmet lock

SECURITY ANTI-THEFT HELMET LOCK

With Superior quality Helmet Locks, Greatly to
reduce Helmets damage and missing





APPLICATION
BACKGROUND



APPLICATION BACKGROUND

Based on safety system,aim at safe riding and to effective manage of scooters,E-bicycles,Motorcycles,Bicycles,etc.



2 OPTIONS FOR SWITCH



Bluetooth Unlock
by Mobile APP



IOT Switch Lock
with Serial port

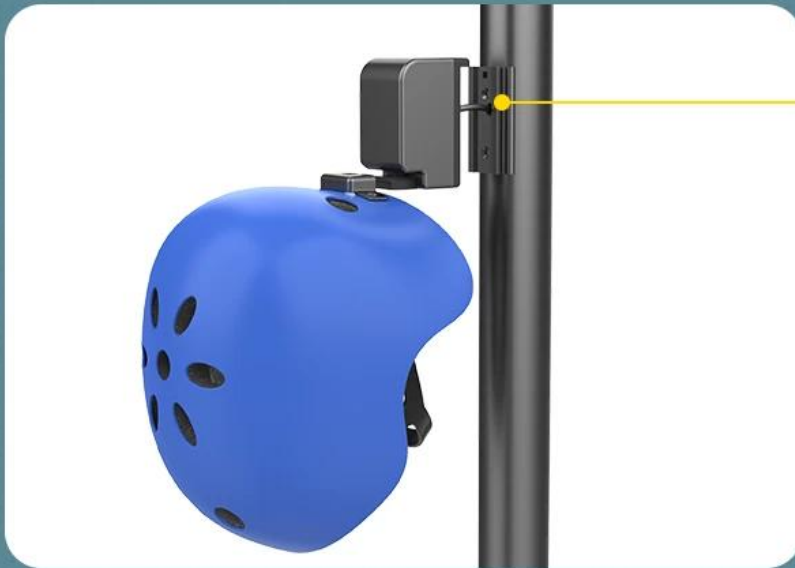

IOT version: Use UART communication wire connect with IOT, IOT can control lock status.

Bluetooth version: Add suitable bracket, connect with phone app via BLE, App remote control lock status.

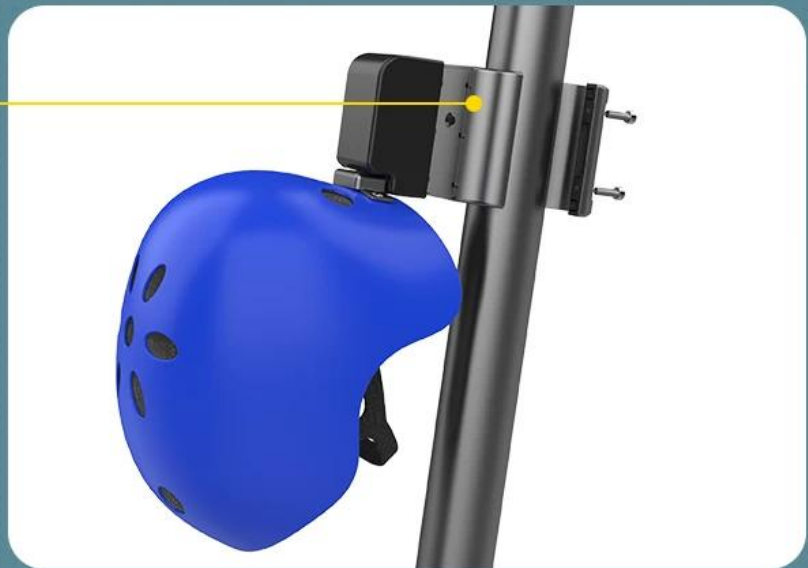

COMPARISON



Other Products in market



Helmets are locked by rope,
Very easy to Knotting,
damaged and missing



Helmets placed in a fixed
station, disconnected with
riding tools, Consume a lot of
time to find station



Helmets hang with rope
disorderly, easy to drop
and crash



Helmets with mechanical
locks, poor efficiency with
manually unlock

VS



Omni's helmet

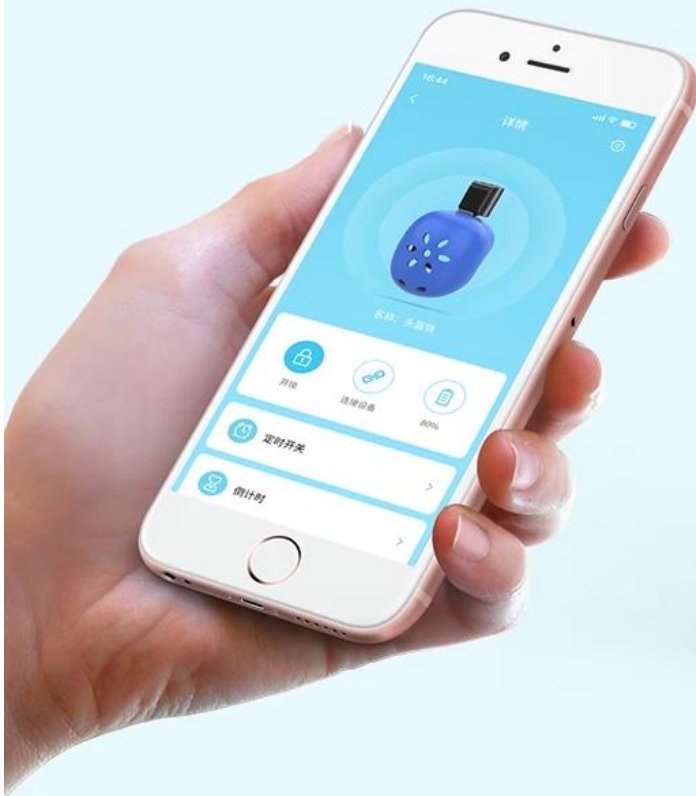

Helmet fixed on tub, Wiring hidden, Aesthetic and minimalist design, Bluetooth wireless connection, APP switch lock/unlock, one-stop easily to manage

PATENTED SECURITY IDENTIFICATION AND ANTI-THEFT TECHNOLOGY



Patented electromagnetic induction
technology Identified Helmets Unlock/Lock for
borrowing and returning



WATERPROOF AND DUSTPROOF



IP67 Degree ,well sealed,easy to
cope with severe weather



WIDE VOLTAGE LITHIUM BATTERY



Use 12-48V wide voltage,
3.6V/3600mAh lithium battery

Multi-voltage
input

Fast
charging

Stable
performance



WIDE RANGE OF APPLICATION SCENARIOS



Mostly used in riding tools such as shared bicycles, electric mopeds, scooters, electric vehicles, motorcycles, etc.



REAL VIEW

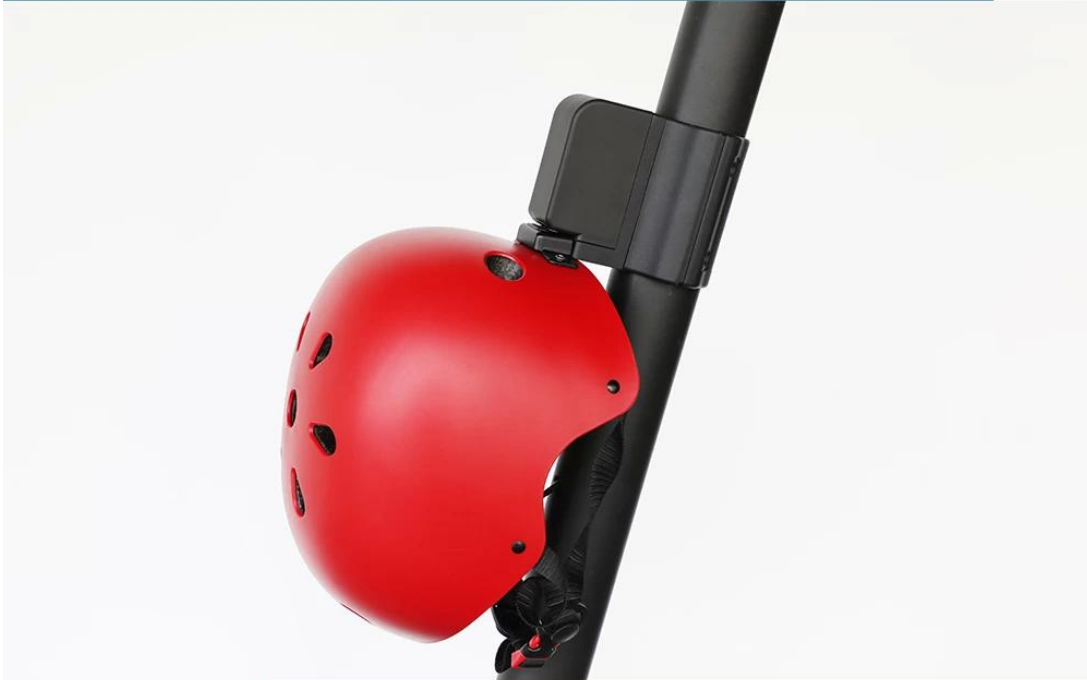



PHYSICAL DIMENSION

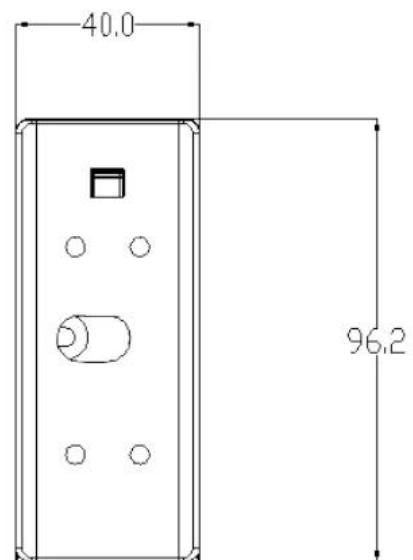
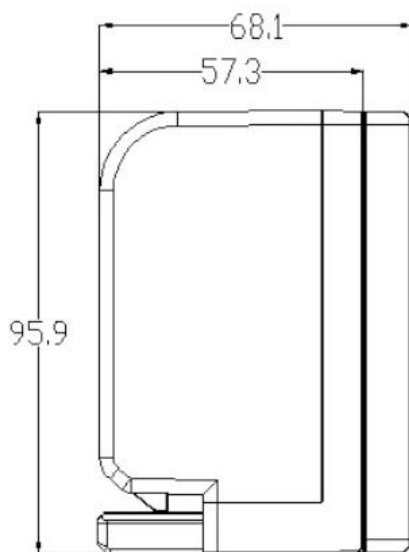

UmOmni

Shenzhen Omni Intelligent Technology Co., Ltd ist auf die Produkte der drahtlosen Kommunikation, der künstlichen Intelligenz und der Sensortechnologie spezialisiert und ist ein nationales High-Tech-Unternehmen, das die Entwicklung von Hardware, Software und Systemlösungen integriert. Omni Produkte sind in mehr als 100 Ländern und Bezirken beliebt und die Produktpaletten sind: [Intelligentes Parkmanagement](#), [Smart-Sharing-Fahrradsystem](#), [Sharing-System für Elektroroller](#), [intelligentes Zuhause](#), [Intelligentes Radfahren](#), intelligente persönliche Produkte und andere künstliche intelligente Hardware und APP, Serverprogramm, Backstage-Managementsystem.

Omni widmet sich der Bereitstellung optimaler intelligenter Produkte, Lösungen und Dienstleistungen für inländische und globale Kunden unter Einhaltung der OMNI Philosophie „Technologieinnovation, Produktaktualisierung, Servicekonzentration“.

The company cases

Intelligent riding system solution

Sharing bike

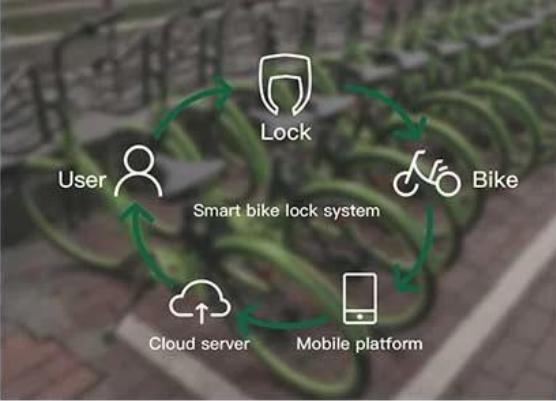

Sharing parking



Sharing scooter



The strength of company

Sales team



Engineering R&D

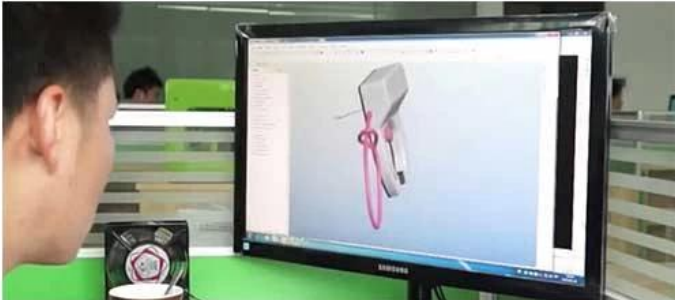

Production plant

